

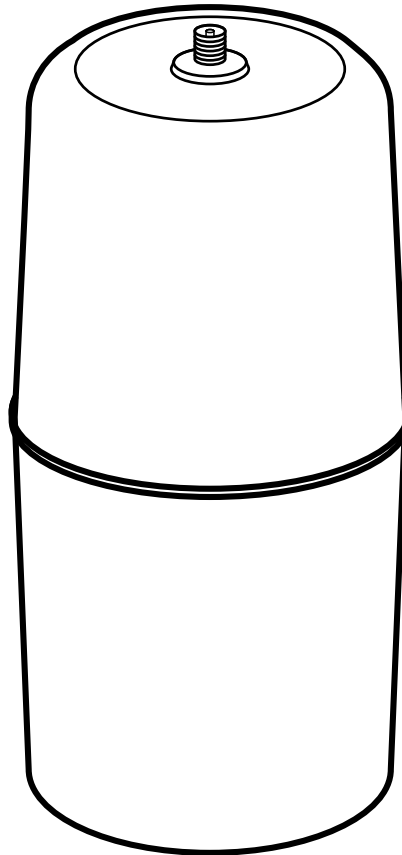

riderite.com

INSTALLATION INSTRUCTIONS



Firestone

Firestone Industrial Products

! IMPORTANT

PLEASE DON'T HURT YOURSELF, YOUR KIT OR YOUR VEHICLE. TAKE A MINUTE TO READ THIS IMPORTANT INFORMATION.

WARNING

Do not inflate this assembly when it is unrestricted. The assembly must be restricted by a coil spring. Do not ever inflate beyond recommended operating pressures for your specific vehicle. Improper use or over inflation may cause property damage or severe personal injury.

SAFE INSTALLATION

Please take all safety precautions during installation. A hydraulic jack can fail, and if that happens, you can be seriously hurt, or worse, if you are relying on it to hold up the vehicle. If you use a hydraulic jack, secure jack stands in the appropriate locations and chock any tires still touching the ground.

Wear safety glasses or goggles. Your eyes may be lower than some parts and pieces, and you don't want to lose an eye.

Remove the possibility of any electrical issues by disconnecting the negative battery cable.

SHOCK ABSORBERS

If necessary, additional clearance between the coil turns may be obtained by removing the shock absorbers from the lower shock mounts and lowering the suspension an additional one to two inches. (CAUTION: Do not put strain or tension on the flexible brake line.

VEHICLE GVWR

NEVER exceed the maximum load recommended by the vehicle manufacturer (GVWR). The GVWR can be found in your vehicle's owner's manual or on the data plate on the driver's side door. Consult your local dealership for additional GVWR specifications.

INFLATING THE AIR SPRINGS

When inflating air springs, add air pressure in small quantities, checking air pressure frequently. The air springs have much less air volume than a tire, so they inflate much more quickly.

APPROPRIATE AIR PRESSURE

For best ride, use only enough air pressure in the air springs to level the vehicle when viewed from the side (front to rear). This will vary, depending on the load, location of the load, condition of the existing suspension, and personal preference.

OPTIONAL T-FITTING

This kit includes inflation valves and air line tube for each air spring, allowing you to compensate for unbalanced loads. If you prefer a single inflation valve system to provide equal pressure to both air springs, your dealer can supply the optional "T" fitting (Part # 3025 or WRI-760-3461 retail pack).



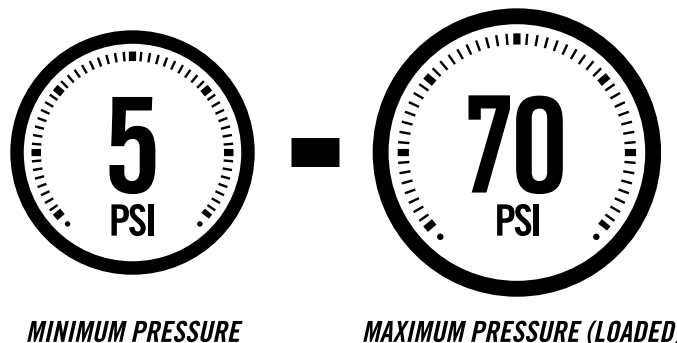

ONCE INSTALLED SUCCESSFULLY, FOLLOW THESE PRESSURE REQUIREMENTS FOR THE AIR SPRINGS:







PARTS

Compare the parts below to your kit. Assure you have all pieces, and organize them for an easier installation.

MAIN KIT CONTENTS

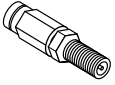
PT # 6134	 x2 COIL-RITE AIR SPRING	PT # 0045	 x2 COIL-RITE UPPER SUPPORT	PT # 0056	 x2 COIL-RITE LOWER SUPPORT
PT # 0048	 x1 AIR LINE ASSEMBLY				

4148 HARDWARE PACK

PT # 3033	 x4 5/16" FLAT WASHERS	PT # 3098	 x2 INFLATION VALVE	PT # 9168	 x6 BLACK NYLON TIE
PT # 3098	 x2 VALVE CAP			PT # 0899	 x2 THERMAL SLEEVE

PREPARE THE AIR SPRING FOR INSTALLATION

1

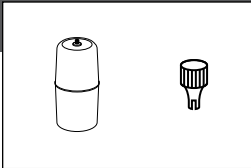

START THE INSTALLATION ON THE LEFT SIDE OF THE VEHICLE WHEN FACING FORWARD.

1 Remove the valve cap from the inflation valve on the air spring.

2 Using the valve cap as a core tool from the inflation valve, remove the valve core from the air spring.

3 Exhaust the air spring by pushing it flat.

4 Re-insert the valve core back into the air spring to keep it collapsed.

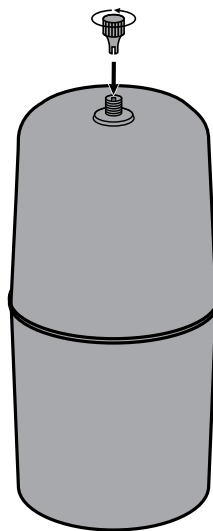

STEP 1

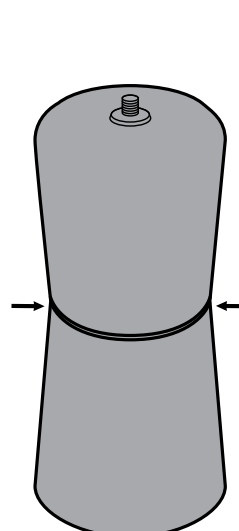

STEP 2

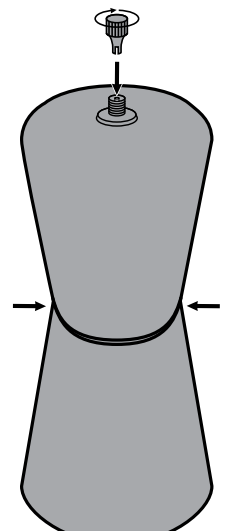

STEP 3

2

INSTALL AIR SPRING INTO COIL SPRING



1 Insert the top of the flattened air spring into the coil spring through the lowest opening with the air inlet at the top, as shown.

2 Push the air spring up into the coil spring by hand or with a blunt tool. **DO NOT use anything with sharp edges or corners, as this may damage the air spring.**

3 When the air spring is completely within the coil spring, remove the valve core to let the air back into the air spring. See step 1 for reference. Allow the air spring to return to its normal shape.



DO NOT USE ANY TOOL OR OBJECT WITH SHARP EDGES OR CORNERS. THESE COULD PUNCTURE THE AIR SPRING, RESULTING IN AN AIR SPRING FAILURE THAT IS **NOT WARRANTABLE**.

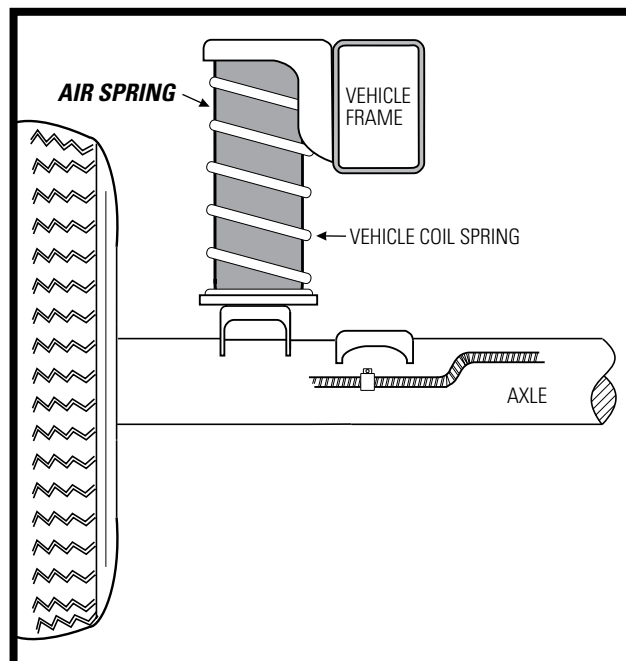
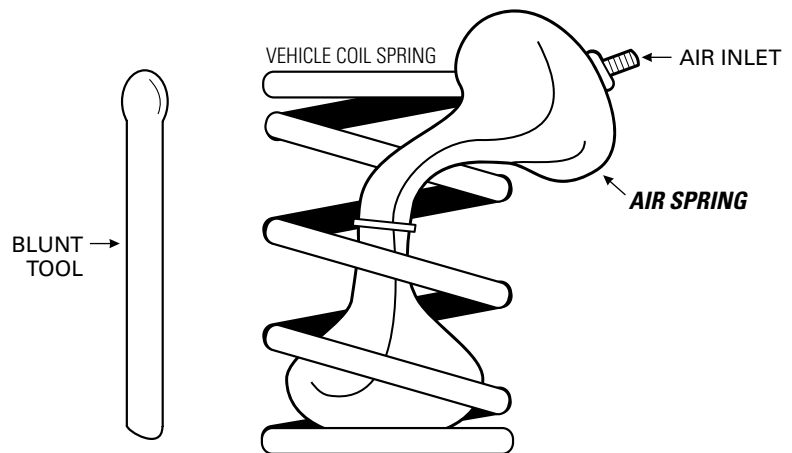

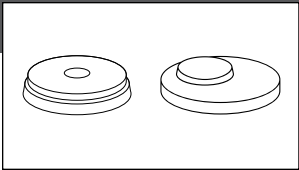

1 Install the upper and lower, as shown below.

2 NOTE: Once the weight of the vehicle is applied to the suspension and the air springs are pressurized, the spacer will stay in place.

3 If removed earlier in the installation, re-attach shock absorbers. Torque to manufacturer's specifications.

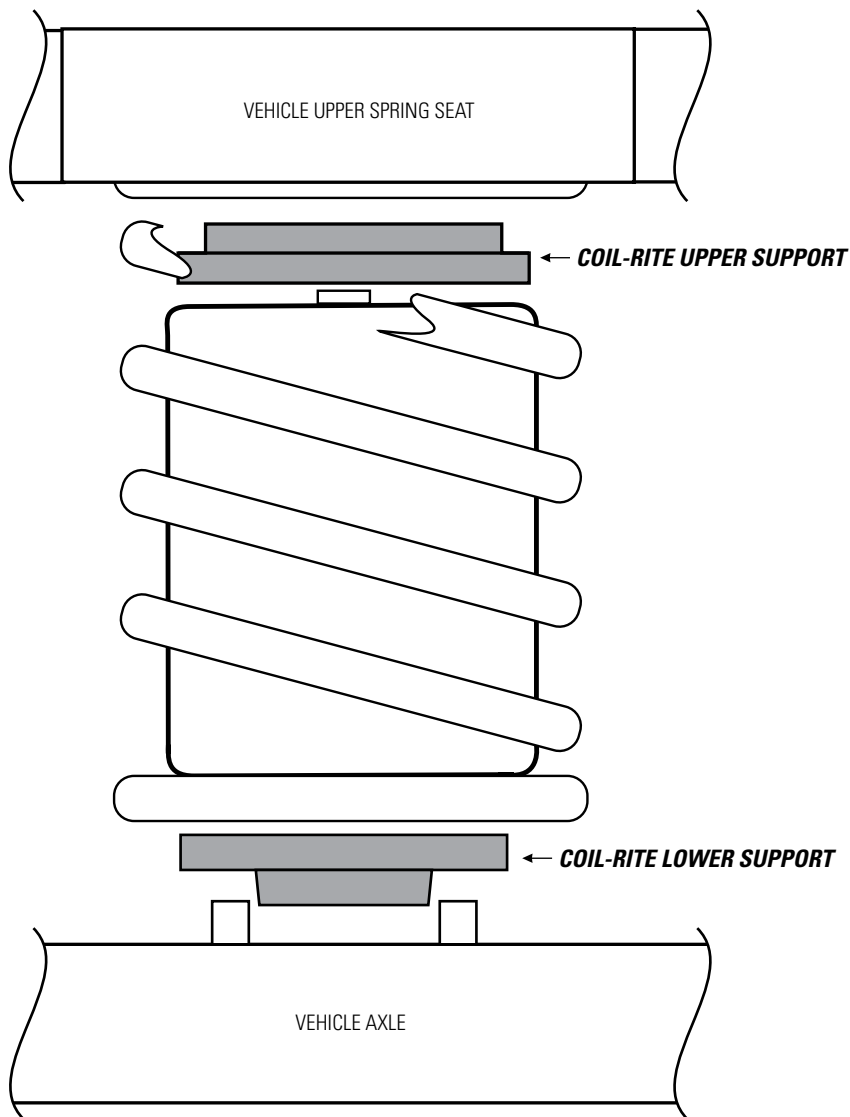

4

INSTALL INFLATION VALVES

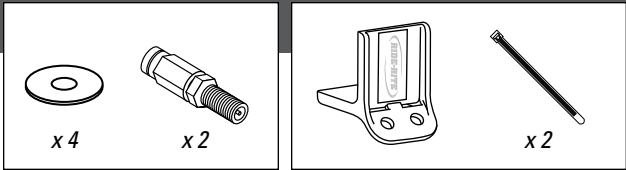

IF USING THE OPTIONAL NO-DRILL INFLATION VALVE BRACKET, CHOOSE OPTION 1. IF DRILLING, CHOOSE OPTION 2. **INFLATION VALVES MUST BE ACCESSIBLE BY AN AIR CHUCK.**

1 Secure the air inflation valve bracket to a protected, secure location. PROCEED TO STEP 3.

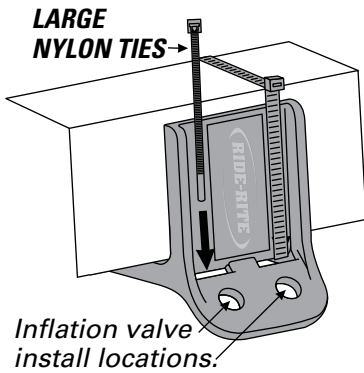

2 Select a protected location to install the inflation valves, such as the bumper or the body of the vehicle.

Drill two 5/16" holes for inflation valve install locations.

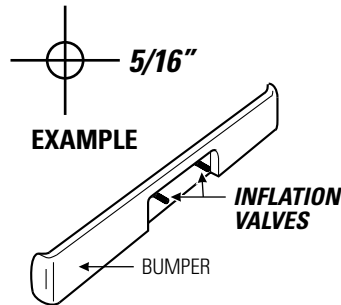

3 Install inflation valve assembly as shown.

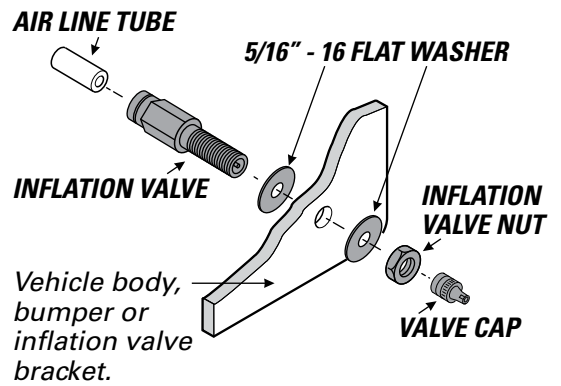

5

CUT THE AIR LINE TUBE INTO TWO EQUAL LENGTHS

1 Match air line tube ends.

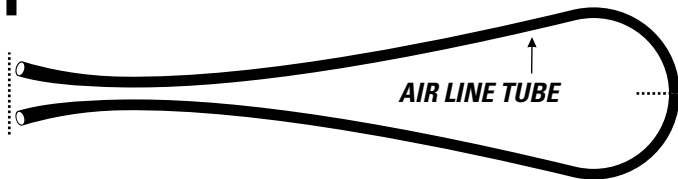

2 Find center of air line tube, make a square cut with tube cutter or sharp utility knife.

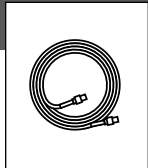

DO

Make sure the cut is as square as possible. Use a tube cutter or sharp utility knife.

DON'T

Fold or kink the air line tube. Cut the air line tube at an angle. Use pliers, scissors, snips, Saws, or side cutters.

PROPER AND IMPROPER CUTS IN THE AIR LINE TUBE

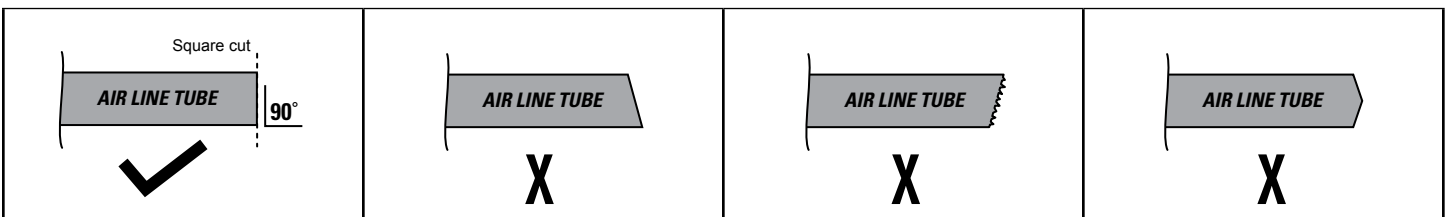

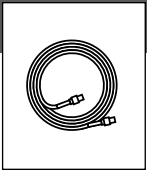

- 1** Screw the fitting that is on the air line tubing onto the air spring inflation valve stem coming out of the air spring.
- 2** Route the tubing from the air spring to the inflation valve install location, making sure to avoid direct heat from the engine or exhaust pipe, and away from sharp edges.

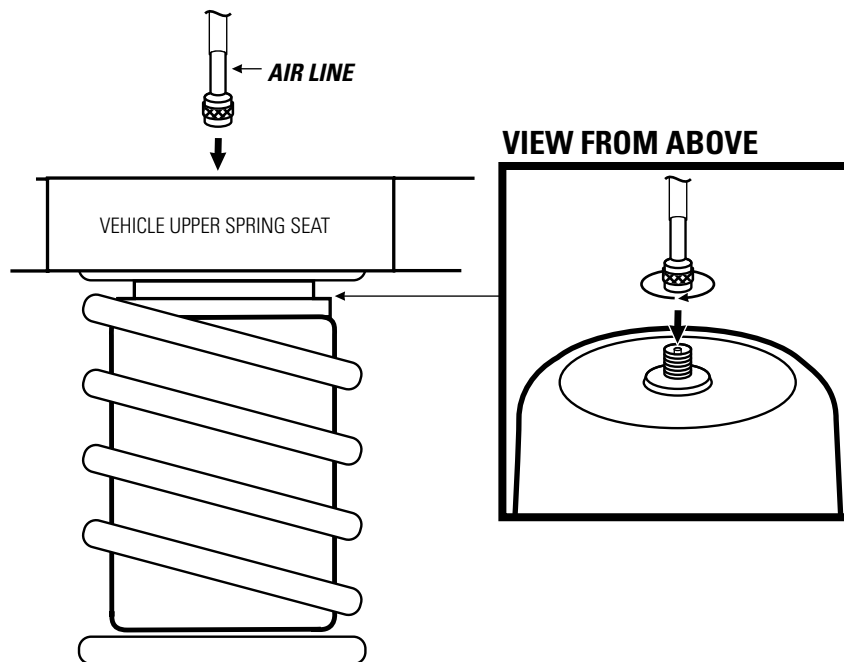

AWESOME! You're done with the left side. Follow the same steps for the right side, then proceed to step 7 to finish installation.

7

INSTALLING AIR LINE TUBE INTO AIR FITTINGS AND INFLATION VALVE

1 Insert end of air line tube into air fitting.

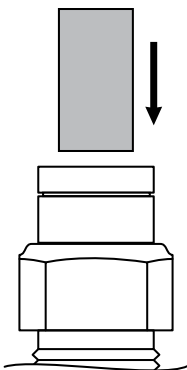

2 Push air line tube into air fitting as far as possible.

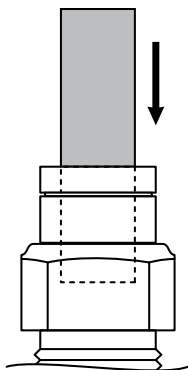

3 Gently pull on the air line tube to check for a secure fit.

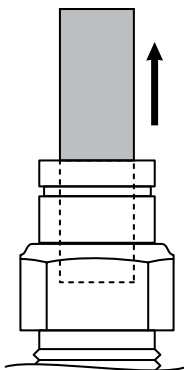

4 To remove, push down collar and gently pull air line tube away.

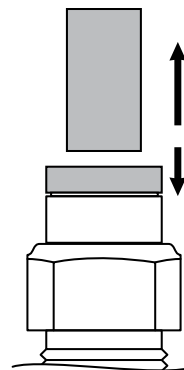

Removal Tip: Use a 1/4", 5/16", or 6mm open-ended wrench to push the collar down.

8

ROUTE AND SECURE AIR LINE TUBES

Air line tube routes will vary, depending on your truck, and requires you to choose the best path from the air springs to the inflation valves. Use the instructions below to help you choose.

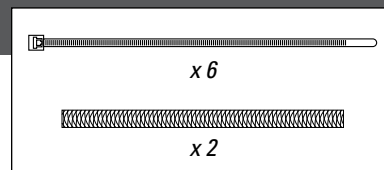

DO

Select routes protected from heat, Debris, and sharp edges.
Use thermal shields near heat sources.
Use Nylon ties to secure the air line tube.

DON'T

Bend or sharply curve air line tubes.
Leave air line tube exposed to sharp edges.
Use unnecessary lengths of air line tube.
Route air line tube near moving parts.
Let air line tube hang unsecured from vehicle.
Scar air line tube while routing.

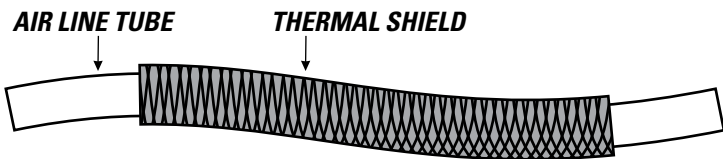

USE SUPPLIED THERMAL SHIELDS WHEN AIR LINE TUBE RUNS **WITHIN 6 INCHES** OF HEAT SOURCES.

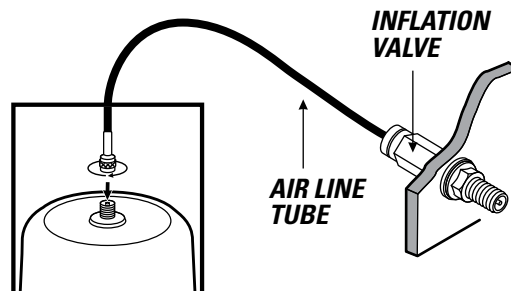
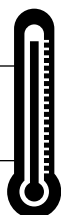

- 1** Place an air chuck onto the inflation valve and fill the system to **70 PSI**.

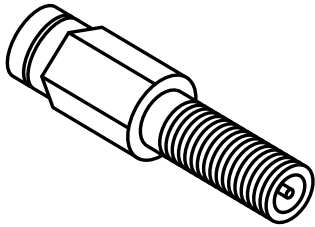

AIR SPRINGS INFLATE QUICKLY. CHECK AIR PRESSURE WHILE INFLATING.

- 2** Spray fittings with soap and water mixture or glass cleaner.



- 3** Observe bubbles.

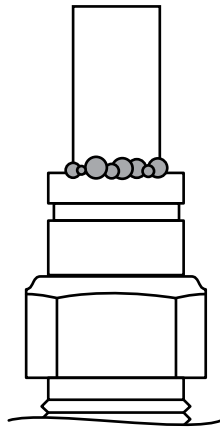

**SMALL SOAP BUBBLES
THAT DO NOT EXPAND**

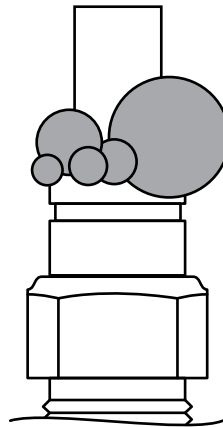

**SOAP BUBBLES
THAT EXPAND**



NO LEAKS?

Congratulations! Continue to step 11 to finish installation. Review the Operating Instructions.

LEAK?

Bummer. Continue to step 10 to fix the leak.

10

FIXING AN AIR LEAK

- 1 Press the air valve on end of inflation valve to release all air pressure.

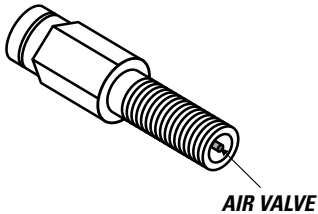

EXHAUST ALL AIR FROM THE SYSTEM PRIOR TO RELEASING AIR LINE TUBES FROM AIR FITTINGS.

LEAK AT AIR LINE TUBE AND AIR FITTING

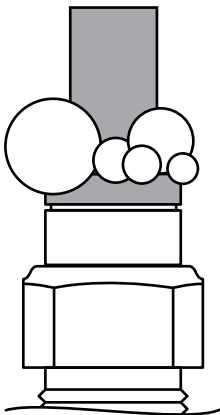

Release air line tube (see page 7). Review proper cuts and procedures in step 5. Repeat steps 7 and 9.

LEAK AT BASE OF AIR FITTING ON AIR SPRING

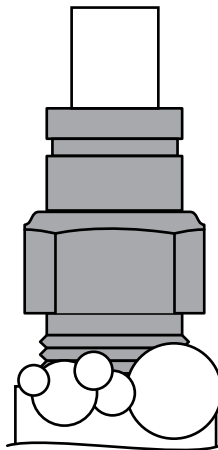

Tighten air fitting one turn or until leak stops.

LEAK OUT OF THE VALVE CORE ON INFLATION VALVE

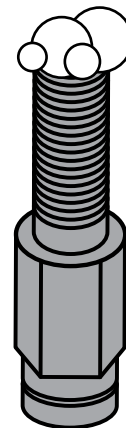

Tighten valve core with valve core wrench on inflation valve cap.

STILL HAVE A LEAK?

Refer to the Troubleshooting section of the Instruction Manual.

SAFELY RETURN VEHICLE TO OPERATIVE STATE

If you removed any wheels during installation, install the wheels and torque the lug nuts to the manufacturer's specifications.

Safely remove any jack stands and wheel chocks used during installation.

Re-attach the negative battery cable.

VEHICLE GVWR

NEVER exceed the maximum load recommended by the vehicle manufacturer (GVWR). The GVWR can be found in your vehicle's owner's manual or on the data plate on the driver's side door. Consult your local dealership for additional GVWR specifications.

READ AND UNDERSTAND THE OPERATING INSTRUCTIONS

The Coil-Rite system can improve handling and comfort. Take a moment to review the operating instructions before hitting the road.

! IMPORTANT

A MINIMUM OF 5 PSI MUST BE MAINTAINED IN THE AIR SPRINGS AT ALL TIMES

Too much air pressure in the air springs will result in a firmer ride, while too little air pressure will allow the air springs to bottom out over rough conditions, and will not provide the improvement in handling that is possible.

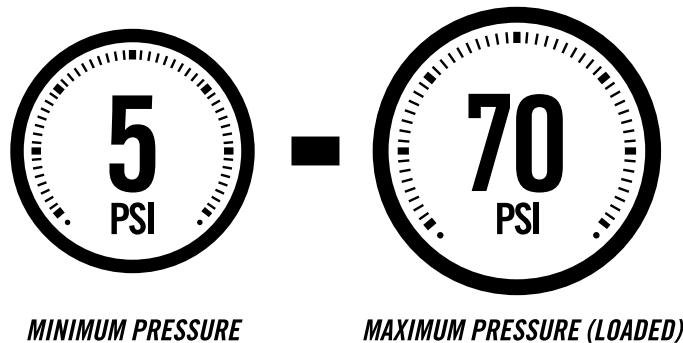



riderite.com

BEFORE YOU DRIVE, CONFIRM THE FOLLOWING:

- Do you have a minimum of 5PSI in your air springs?
- Put your paper work back into the sleeve and keep it in your glove compartment for future reference.
- You've been bagged...and now your suspension is Airide™ equipped! Show it off with the supplied decal!

NEED INSTALLATION HELP?

Email us at rrtech@fsip.com. Please include photos to help us better diagnose and understand any problems you may be experiencing.

Firestone

Firestone Industrial Products

CONNECT WITH US



FirestoneIP



Firestone Ride-Rite